

SLM150N03T

30V N -Channel MOSFET

General Description

This Power MOSFET is produced using Maple semi's advanced planar stripe TRENCH technology. This advanced technology has been especially tailored to minimize conduction loss, provide superior switching performance, and withstand high energy pulse in the avalanche and commutation mode.

Application

- PWM Application
- Load Switch
- Power Management

Features

- N-Channel: 30V 150A
 - $R_{DS(on)Typ} = 2.4m\Omega @ V_{GS} = 10V$
 - $R_{DS(on)Typ} = 4.3m\Omega @ V_{GS} = 4.5V$
- Very Low On-resistance RDS(ON)
- Low Crss
- Fast switching
- 100% avalanche tested
- Improved dv/dt capability



DFN5*6

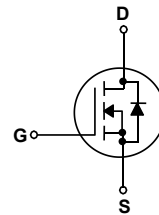
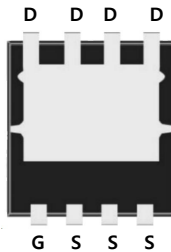

Absolute Maximum Ratings

$T_C = 25^\circ\text{C}$ unless otherwise noted

Symbol	Parameter	SLM150N03T	Units
V_{DSS}	Drain-Source Voltage	30	V
I_D	Drain Current - Continuous ($T_C = 25^\circ\text{C}$) - Continuous ($T_C = 100^\circ\text{C}$)	150	A
		98	A
I_{DM}	Drain Current - Pulsed (Note 1)	600	A
V_{GSS}	Gate-Source Voltage	± 20	V
E_{AS}	Single Pulsed Avalanche Energy	225	mJ
P_D	Power Dissipation ($T_C = 25^\circ\text{C}$)	108	W
$R_{\theta JC}$	Thermal Resistance, Junction to Case	1.3	$^\circ\text{C/W}$
T_J, T_{STG}	Operating and Storage Temperature Range	-55 to +150	$^\circ\text{C}$
T_L	Maximum lead temperature for soldering purposes, 1/8" from case for 5 seconds	300	$^\circ\text{C}$

* Drain current limited by maximum junction temperature.

Electrical Characteristics $T_C = 25^\circ\text{C}$ unless otherwise noted

Symbol	Parameter	Test Conditions	Min	Typ	Max	Units
--------	-----------	-----------------	-----	-----	-----	-------

Off Characteristics

BV_{DSS}	Drain-Source Breakdown Voltage	$V_{GS} = 0\text{ V}, I_D = 250\text{ }\mu\text{A}$	30	--	--	V
I_{DSS}	Zero Gate Voltage Drain Current	$V_{DS} = 30\text{ V}, V_{GS} = 0\text{ V}$	--	--	1	μA
		$V_{DS} = 24\text{ V}, T_C = 125^\circ\text{C}$	--	--	10	μA
I_{GSSF}	Gate-Body Leakage Current, Forward	$V_{GS} = 20\text{ V}, V_{DS} = 0\text{ V}$	--	--	100	nA
I_{GSSR}	Gate-Body Leakage Current, Reverse	$V_{GS} = -20\text{ V}, V_{DS} = 0\text{ V}$	--	--	-100	nA

On Characteristics

$V_{GS(th)}$	Gate Threshold Voltage	$V_{DS} = V_{GS}, I_D = 250\text{ }\mu\text{A}$	1.0	1.4	2.5	V
$R_{DS(on)}$	Static Drain-Source On-Resistance	$V_{GS} = 10\text{ V}, I_D = 30\text{ A}$	--	2.4	3.3	$\text{m}\Omega$
	Static Drain-Source On-Resistance	$V_{GS} = 4.5\text{ V}, I_D = 20\text{ A}$	--	4.3	6.0	

Dynamic Characteristics

C_{iss}	Input Capacitance	$V_{DS} = 15\text{ V}, V_{GS} = 0\text{ V},$ $f = 1.0\text{ MHz}$	--	3500	-	pF
C_{oss}	Output Capacitance		--	500	-	pF
C_{rss}	Reverse Transfer Capacitance		--	431	-	pF

Switching Characteristics

$t_{d(on)}$	Turn-On Delay Time	$V_{GS} = 10\text{ V}, V_{DS} = 15\text{ V},$ $R_G = 3\text{ }\Omega, I_D = 30\text{ A}$	--	26	--	ns
t_r	Turn-On Rise Time		--	24	--	ns
$t_{d(off)}$	Turn-Off Delay Time		--	91	--	ns
t_f	Turn-Off Fall Time		--	39	--	ns
Q_g	Total Gate Charge	$V_{DS} = 15\text{ V}, I_D = 30\text{ A},$ $V_{GS} = 10\text{ V}$	--	38	--	nC
Q_{gs}	Gate-Source Charge		--	9	--	nC
Q_{gd}	Gate-Drain Charge		--	13	--	nC

Drain-Source Diode Characteristics and Maximum Ratings

I_S	Maximum Continuous Drain-Source Diode Forward Current	--	--	150	A
I_{SM}	Maximum Pulsed Drain-Source Diode Forward Current	--	--	600	A
V_{SD}	Drain to Source Diode Forward Voltage, $V_{GS} = 0\text{ V}, I_{SD} = 30\text{ A}, T_J = 25^\circ\text{C}$	--	--	1.2	V
t_{rr}	Body Diode Reverse Recovery Time $I_F = 20\text{ A}, dI/dt = 100\text{ A}/\mu\text{s}$	--	42	--	ns
Q_{rr}	Body Diode Reverse Recovery Charge $I_F = 20\text{ A}, dI/dt = 100\text{ A}/\mu\text{s}$	--	39	--	nC

Notes:

1. Repetitive Rating: Pulse Width Limited by Maximum Junction Temperature
2. EAS condition: $T_J = 25^\circ\text{C}, V_{DD} = 15\text{ V}, V_G = 10\text{ V}, R_G = 25\Omega, L = 0.5\text{ mH}, I_{AS} = 30\text{ A}$
3. Pulse Test: Pulse Width $\leq 300\mu\text{s}$, Duty Cycle $\leq 0.5\%$

N- Channel Typical Characteristics

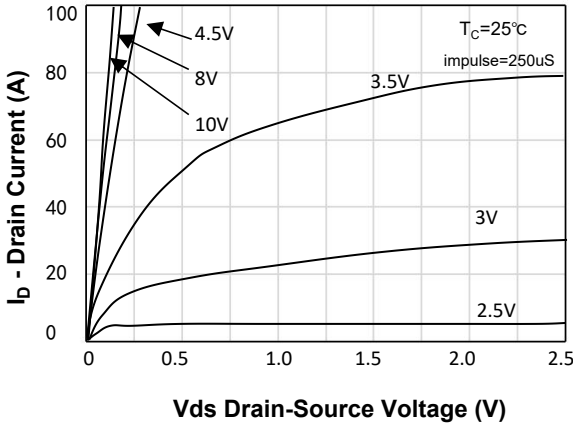

Figure 1. On-Region Characteristics

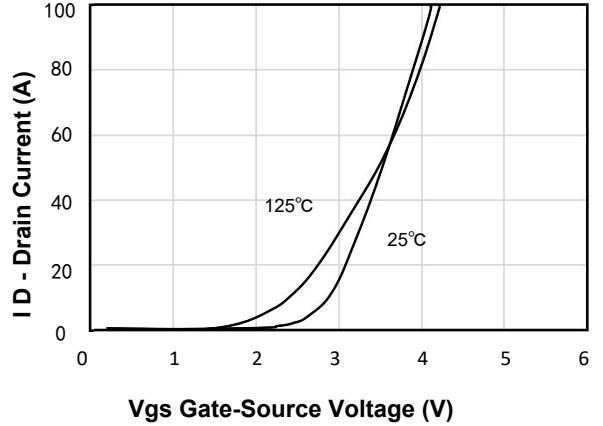

Figure 2. Transfer Characteristics

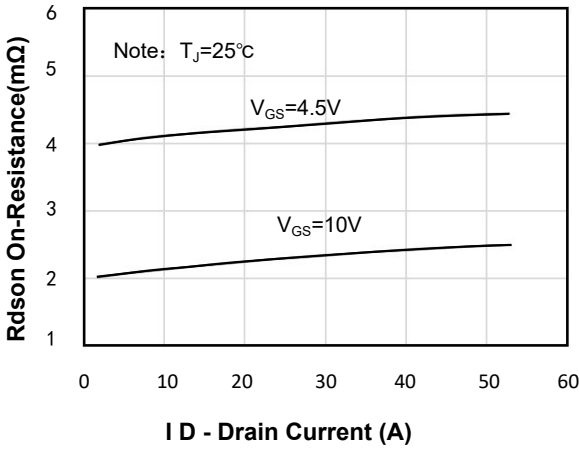

Figure 3. On-Resistance Variation vs Drain Current and Gate Voltage

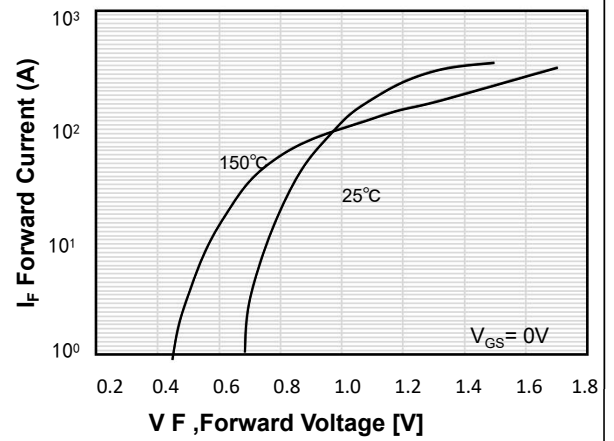

Figure 4. Body Diode Forward Voltage Variation with Source Current and Temperature

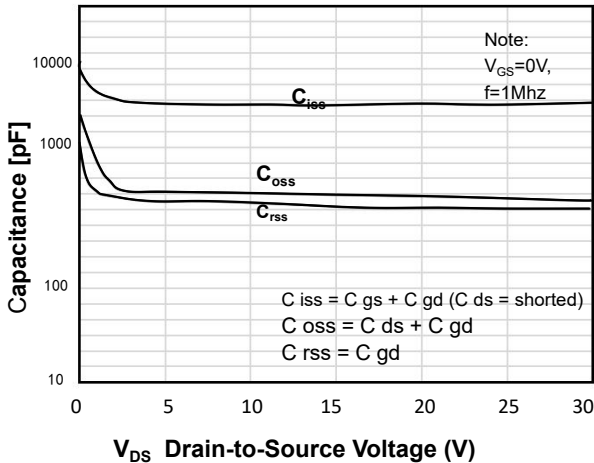

Figure 5. Capacitance Characteristics

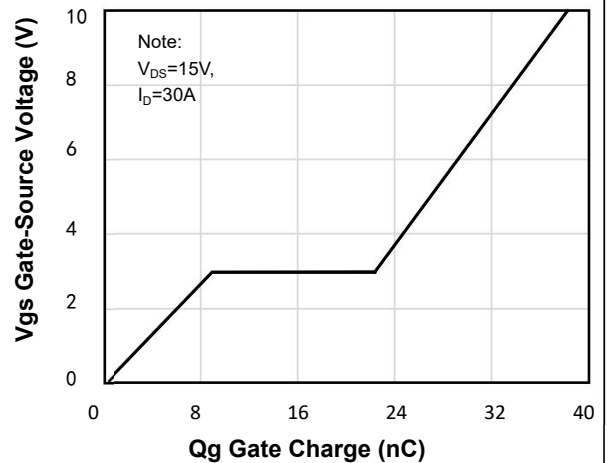

Figure 6. Gate Charge Characteristics

N- Channel Typical Characteristics (Continued)

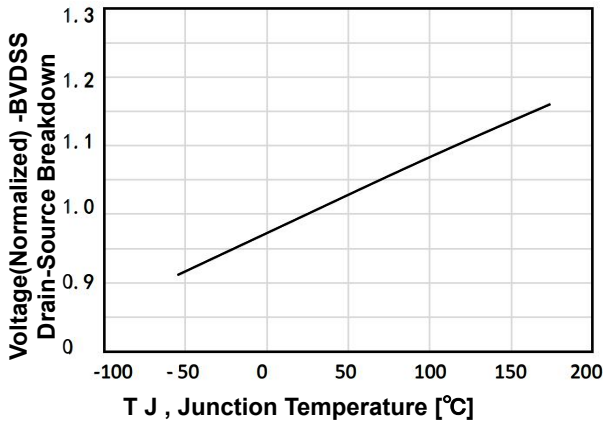

Figure 7. Breakdown Voltage Variation vs Temperature

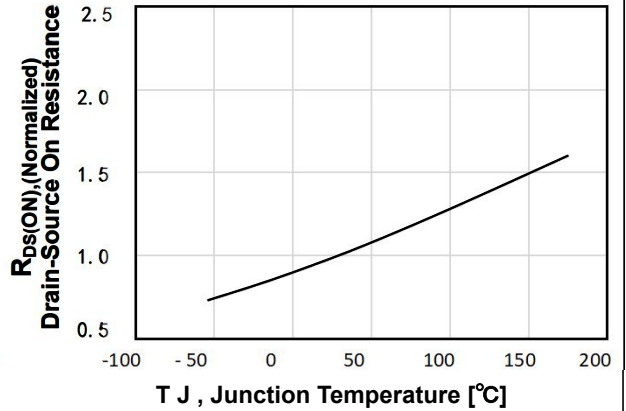

Figure 8. On-Resistance Variation vs Temperature

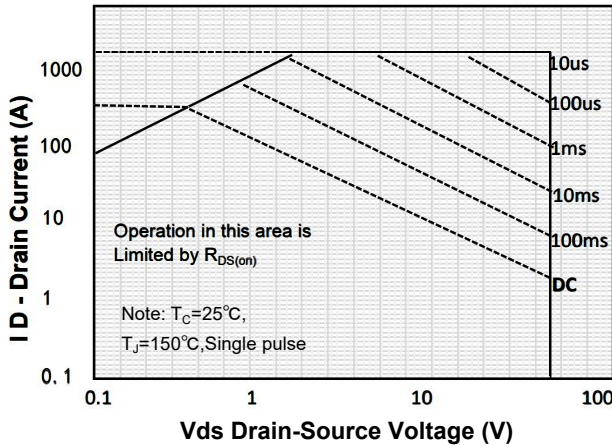

Figure 9. Maximum Safe Operating Area

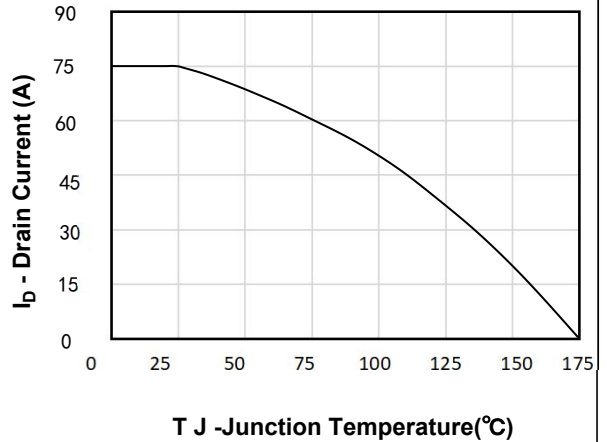

Figure 10. Maximum PContinuous Drain Currentvs Case Temperature

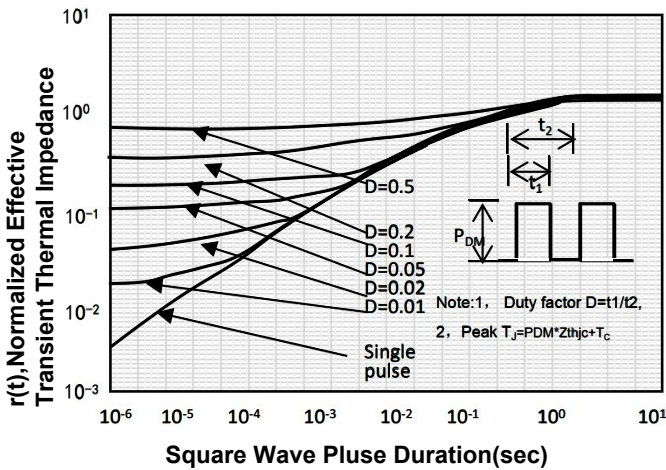
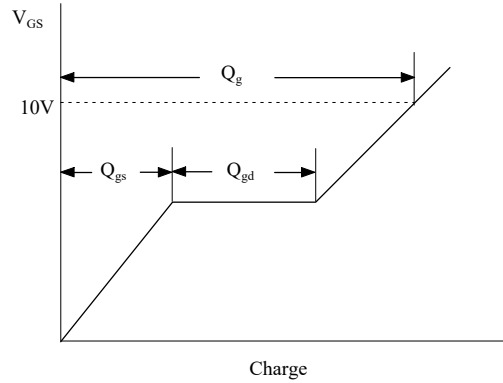
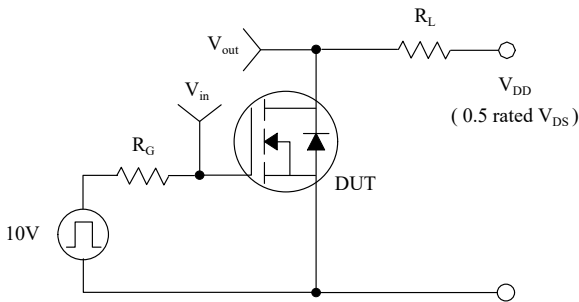

Figure 11. Transient Thermal Response Curve

Gate Charge Test Circuit & Waveform



Resistive Switching Test Circuit & Waveforms



Unclamped Inductive Switching Test Circuit & Waveforms



$$E_{AS} = \frac{1}{2} L_L I_{AS}^2$$

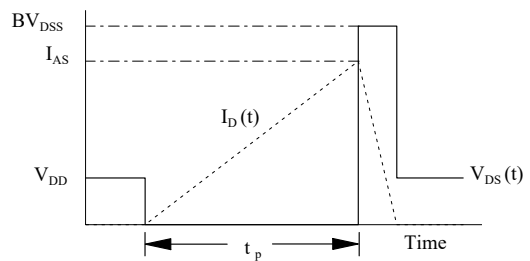

Peak Diode Recovery dv/dt Test Circuit & Waveforms

